

A decorative graphic consisting of two stylized reeds with long, thin blades and three dark, oval-shaped seed heads on each. The reeds are positioned on either side of the text, with their bases meeting at a horizontal line that underlines the text.

COULSON GARDENS

BOCKING | ESSEX



BOCKING WINDMILL,
BOCKING

BOCKING & BRAINTREE, ESSEX

Nestled in the heart of Braintree District, Bocking is steeped in history and surrounded by countryside. Close to the vibrant town of Braintree, 10 miles north-east of Chelmsford and 15 miles west of Colchester, Bocking is perfectly situated to complement a variety of lifestyles.

Enjoy an afternoon relaxing in Braintree & Bocking Public Gardens, walking along the public footpaths through the local countryside, or exploring the wildlife at Great Notley Country Park.

Experience the excitement of a day at Chelmsford Racecourse watching horse racing, or be entertained during one of the many live shows. Braintree Golf Club, the local Fennes Fisheries and Bocking Alliance Bowls Club also offer excellent community spirited activities.



RIVER BLACKWATER,
BOCKING



**WALLED GARDENS,
CRESSING TEMPLE**



**WILLY LOTT'S COTTAGE,
DEDHAM VALE AONB**



**BRAINTREE GOLF CLUB,
BOCKING**

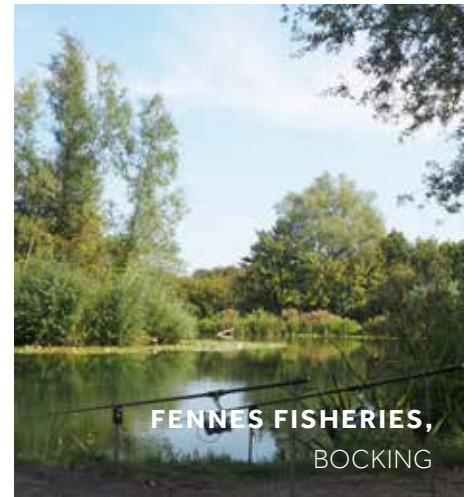

**FENNES FISHERIES,
BOCKING**

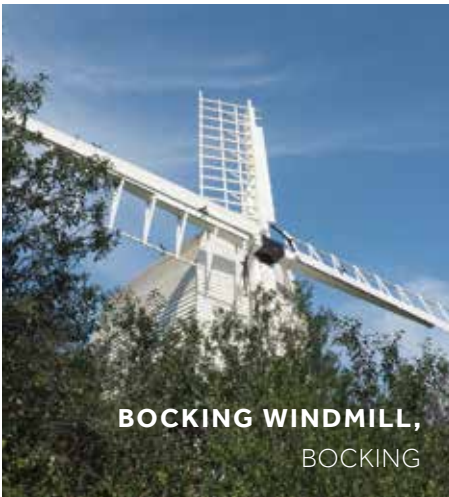

**BOCKING WINDMILL,
BOCKING**



**COLCHESTER CASTLE,
COLCHESTER**

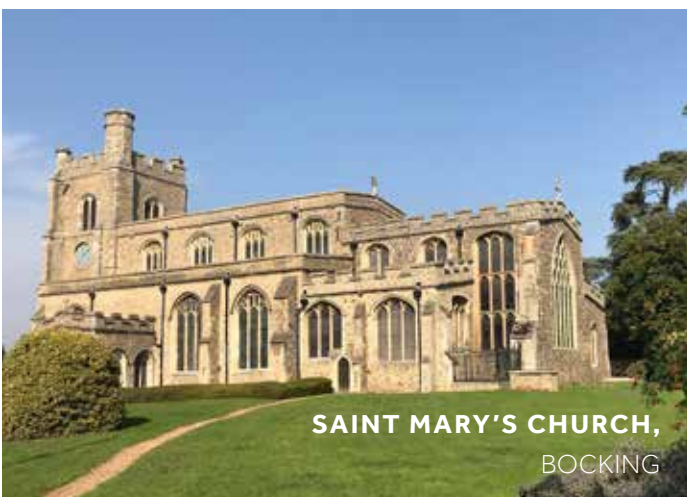

**SAINT MARY'S CHURCH,
BOCKING**



**A HOUSE FOR ESSEX,
WRABNESS**

SCOTT RESIDENTIAL

Scott Residential is a local, family-run business specialising in delivering high quality homes specifically designed to keep people living independently for longer.

Scott Residential build traditionally properties finished to an extremely high standard, offering impressive, thoughtful design, featuring carefully chosen materials with meticulous attention to detail; where modern day needs have been considered from the outset.

Coulson Gardens is an exclusive collection of 2, 3 & 4 bedroom traditionally built homes with superb specifications.



THE JASMINE,
Gainsford Gardens



THE WISTERIA,
Gainsford Gardens



THE BEGONIA,
Avocet Place



THE DAISY
2 Bedrooms, Bathroom & En suite
Plots 7 & 15



THE LILY
2 Bedrooms, Bathroom & En suite
Plots 2, 9 & 10



THE BEGONIA
2 Bedrooms & Bathroom
Plot 1



THE JASMINE
3 Bedrooms, Bathroom & En suite
Plots 3, 4 & 13



THE MAGNOLIA
3 Bedrooms, Bathroom & En suite
Plots 5, 6, 11 & 12



THE WISTERIA
3 Bedrooms, Bathroom & En suite
Plot 8



THE PRIMROSE
3 Bedrooms, Bathroom, En suite & Cloakroom
Plots 17 & 18



THE FUCHSIA
3 Bedrooms, Bathroom, En suite & Cloakroom
Plots 14 & 16



THE VIOLET
4 Bedrooms, Bathroom, En suite & Cloakroom
Plot 19







CGI indicates
Plot 7

THE **DAISY**

PLOTS 7 & 15

A recent addition to the range, the Daisy sits on a wide plot with a functional internal layout. The property offers two large bedrooms with en suite shower room to master bedroom, providing the perfect accommodation for people looking to downsize.



Lounge	4.28 x 3.60m	14'0" x 11'10"
Kitchen	3.60 x 3.60m	11'10" x 11'10"
Bedroom 1	3.60 x 3.30m	11'10" x 10'10"
Bedroom 2	2.90 x 3.30m	9'6" x 10'10"
Garage	7.00 x 3.00m	23'0" x 9'10"



Approximate Gross Internal Area 68.9m² / 742ft²

Illustrations are for marketing purposes only; external finishes and dimensions may vary.
Internal room sizes are subject to a 30mm reduction to all walls to allow for internal finishes.

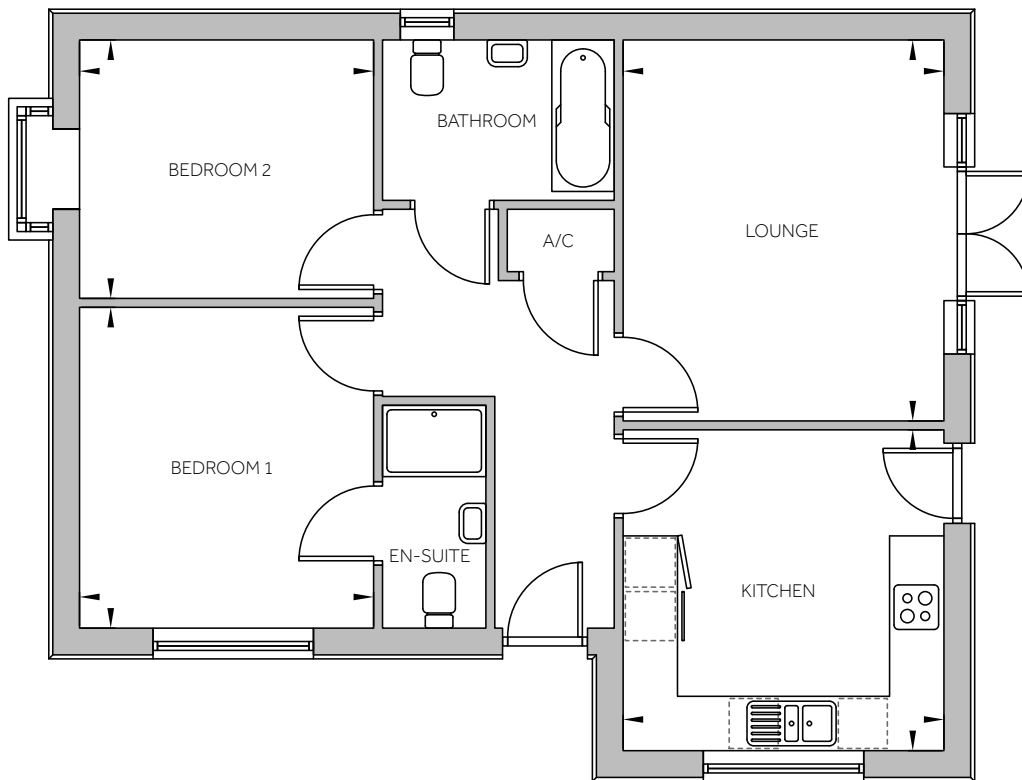
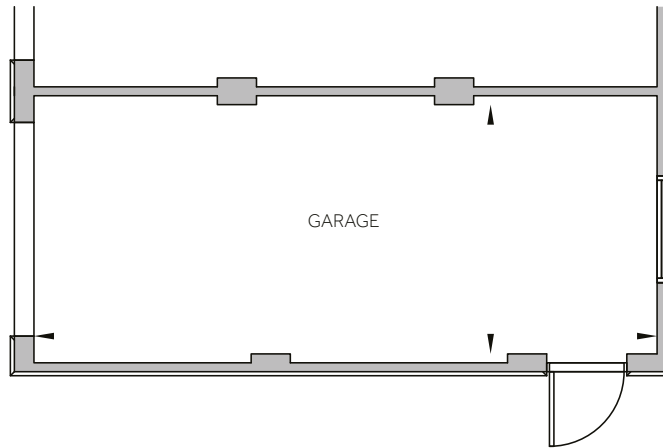

* Variation to Plot 7

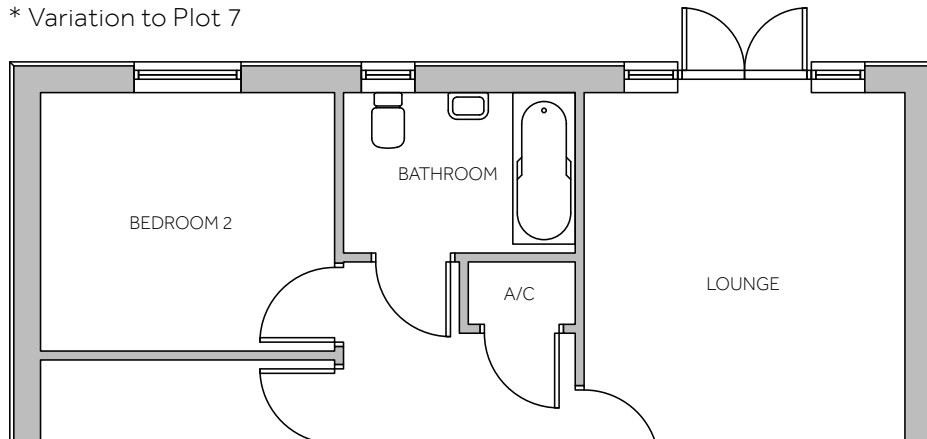

Floor plan indicates Plot 15

* Variation - bedroom 2 window on Plot 7

* Variation - French doors on Plot 7

Semi detached garage location is indicative only





CGI indicates
Plot 2

THE LILY

PLOTS 2, 9 & 10

The Lily is a detached two-bedroom bungalow featuring an en suite shower room to the master bedroom providing separate bathing and shower areas, with well-proportioned accommodation throughout.

	 	 
Lounge	4.20 x 3.70m	13'9" x 12'2"
Kitchen	3.60 x 3.50m	11'10" x 11'6"
Garden Room	3.00 x 3.00m*	9'10" x 9'10"*
Bedroom 1	3.60 x 3.30m	11'10" x 10'10"
Bedroom 2	3.80 x 2.60m	12'6" x 8'6"
Garage	7.00 x 3.00m	23'0" x 9'10"



* Variation - garden room to plot 10 only

Approximate Gross Internal Area 77.1m² / 830ft²
Plots 2 & 9 Approximate Gross Internal Areas 67.2m² / 723ft²

Gross Internal Area includes garden rooms. Illustrations are for marketing purposes only; external finishes and dimensions may vary. Internal room sizes are subject to a 30mm reduction to all walls to allow for internal finishes.

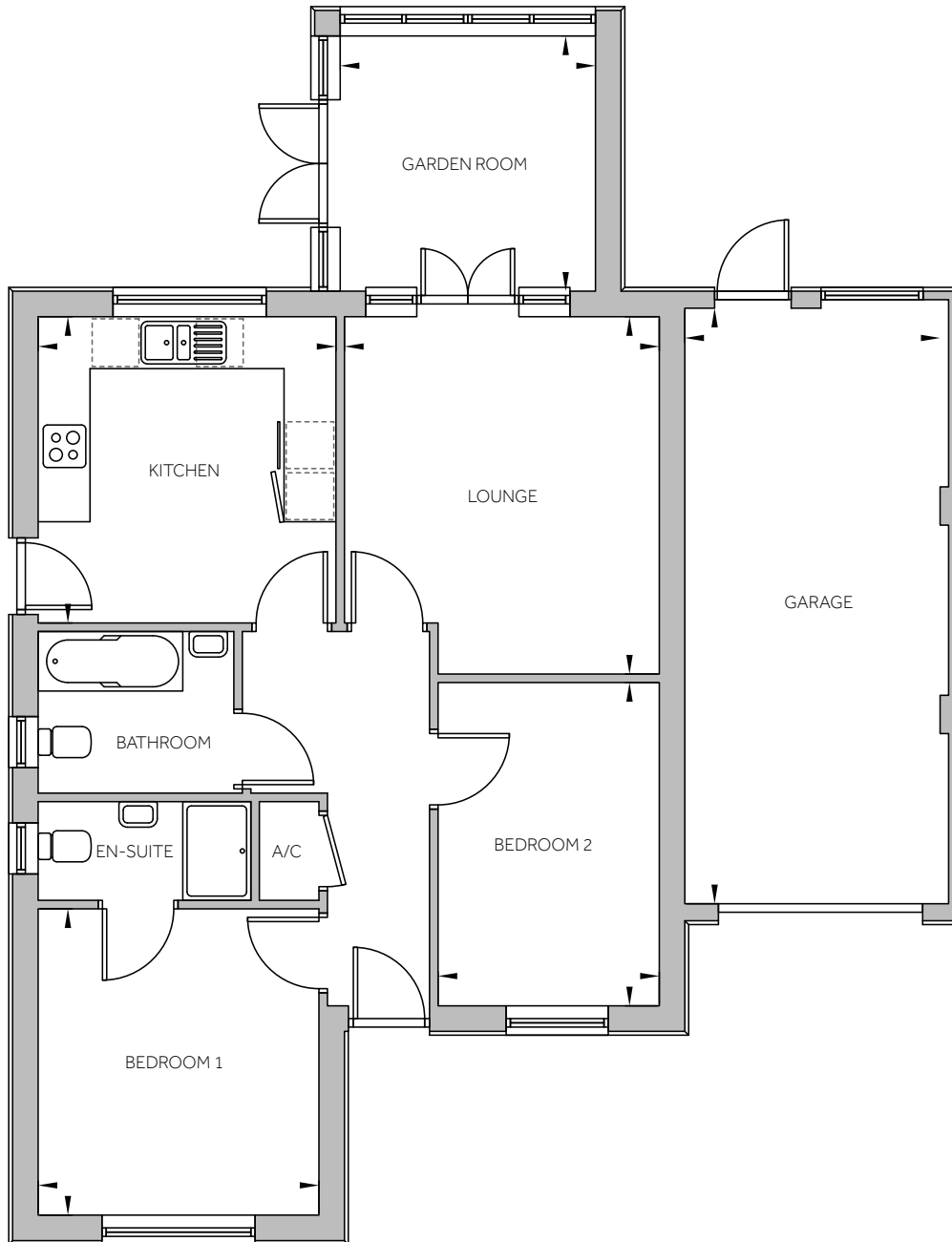

Floor plan indicates Plots 10 & 2

Plot 9 is handed

* Variation - garden room to Plot 10 only



THE **BEGONIA**

PLOT 1

This detached bungalow with integral garage has been thoughtfully designed throughout, with a well proportioned lounge with French doors leading through to the garden room and into the garden. The large kitchen diner offers an additional socialising area for family and friends.

CGI indicates
Plot 1

Lounge	3.91 x 5.50m	12'10" x 18'1"
Kitchen	4.96 x 3.15m	16'3" x 10'4"
Garden Room	3.00 x 3.00m	9'10" x 9'10"
Bedroom 1	3.80 x 3.15m	12'6" x 10'4"
Bedroom 2	2.70 x 3.15m	8'10" x 10'4"
Garage	7.00 x 3.00m	23'0" x 9'10"



Approximate Gross Internal Area 84.7m² / 912ft²

Gross Internal Area includes garden rooms. Illustrations are for marketing purposes only; external finishes and dimensions may vary. Internal room sizes are subject to a 30mm reduction to all walls to allow for internal finishes.

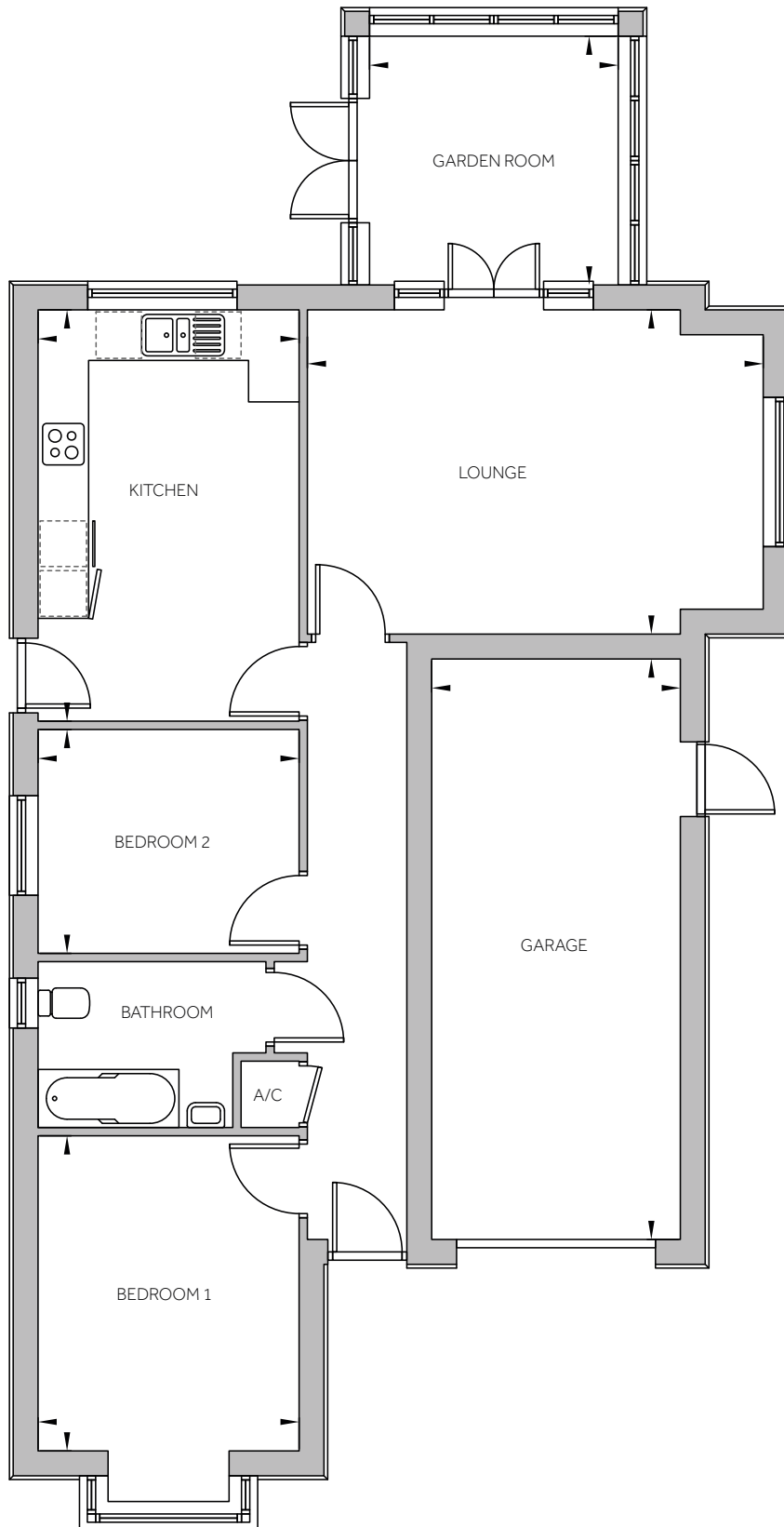

Floor plan indicates Plot 1





THE **MAGNOLIA**

PLOT 5, 6, 11 & 12

The Magnolia, a three-bedroom detached bungalow with detached garage, offers three large bedrooms, en suite shower room to master bedroom, and bathroom with separate bath and shower. A generous kitchen diner and spacious lounge provide ideal spaces for entertaining.

CGI indicates
Plot 5

	 	 
Lounge	4.30 x 4.35m	14'1" x 14'3"
Kitchen	5.40 x 3.55m	17'9" x 11'8"
Garden Room	3.00 x 3.00m	9'10" x 9'10"
Bedroom 1	4.00 x 3.60m	13'1" x 11'10"
Bedroom 2	3.50 x 3.00m	11'6" x 9'10"
Bedroom 3	2.50 x 3.00m	8'2" x 9'10"
Garage	7.00 x 3.00m	23'0" x 9'10"



Approximate Gross Internal Area 103.2m² / 1,111ft²

Gross Internal Area includes garden rooms. Illustrations are for marketing purposes only; external finishes and dimensions may vary. Internal room sizes are subject to a 30mm reduction to all walls to allow for internal finishes.

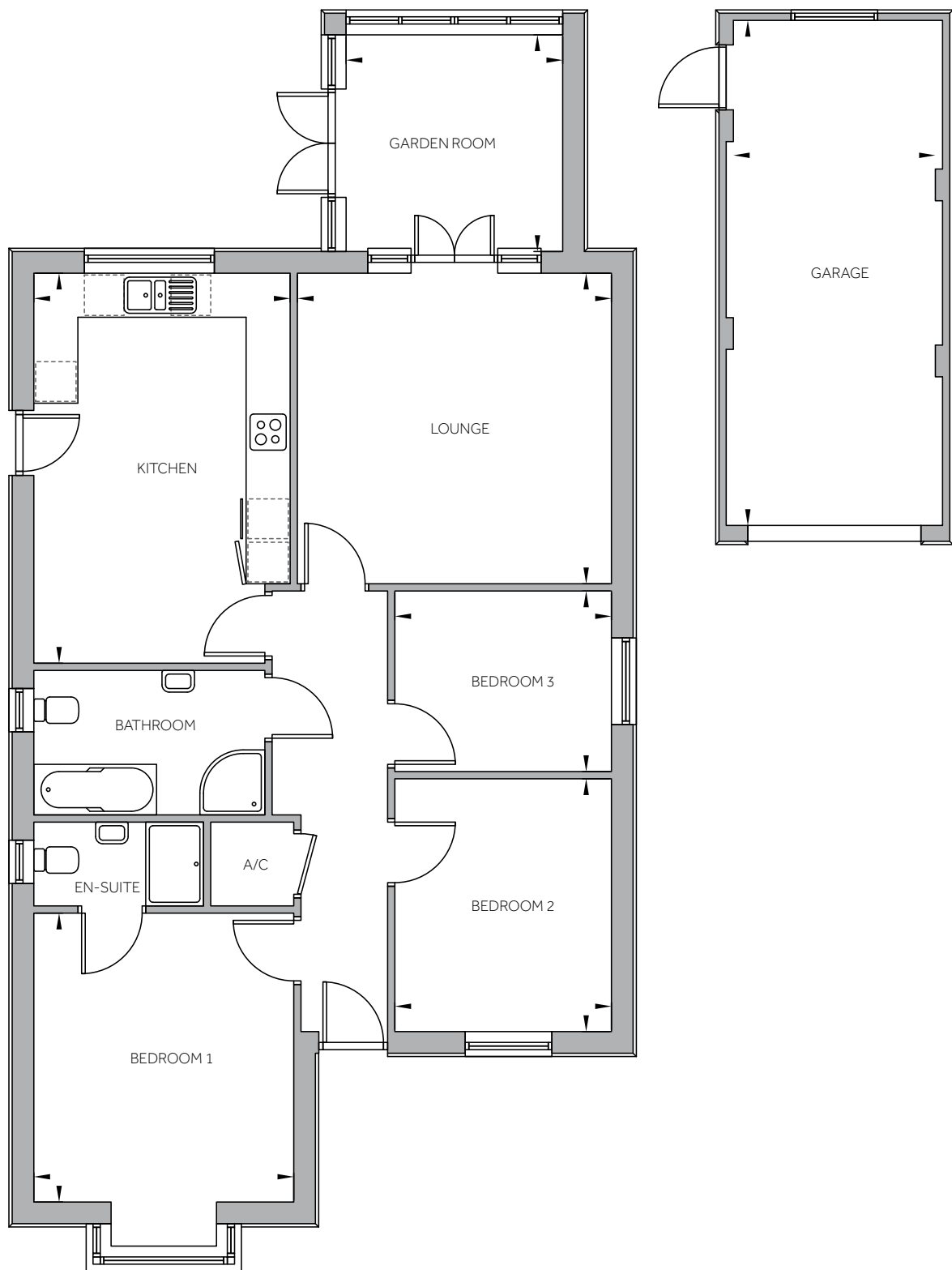

Floor plan indicates Plots 5, 6 & 11
Plot 12 is handed
Garage location is indicative only
Semi detached garages to plots 11 & 12



THE JASMINE

PLOTS 3, 4 & 13

A three-bedroom detached bungalow with adjoining garage, offering a kitchen diner with separate utility and en suite shower room to master bedroom, this bungalow provides a practical layout without compromise. The utility area features integrated washing machine and tumble dryer with second sink.

CGI indicates
Plot 4

Lounge	4.78 x 4.00m	15'8" x 13'1"
Kitchen	3.98 x 3.10m	10'10" x 10'2"
Garden Room	3.00 x 3.00m	9'10" x 9'10"
Bedroom 1	3.84 x 3.70m	12'7" x 12'2"
Bedroom 2	3.24 x 3.40m	10'7" x 11'2"
Bedroom 3	3.67 x 2.80m	12'0" x 9'2"
Garage	7.00 x 3.00m	23'0" x 9'10"

* Variation - garden room to plots 3 & 4 only



Approximate Gross Internal Area 110.7m² / 1,192ft²
Plot 13 Approximate Gross Internal Area 98.2m² / 1,057ft²

Gross Internal Area includes garden rooms. Illustrations are for marketing purposes only; external finishes and dimensions may vary. Internal room sizes are subject to a 30mm reduction to all walls to allow for internal finishes.

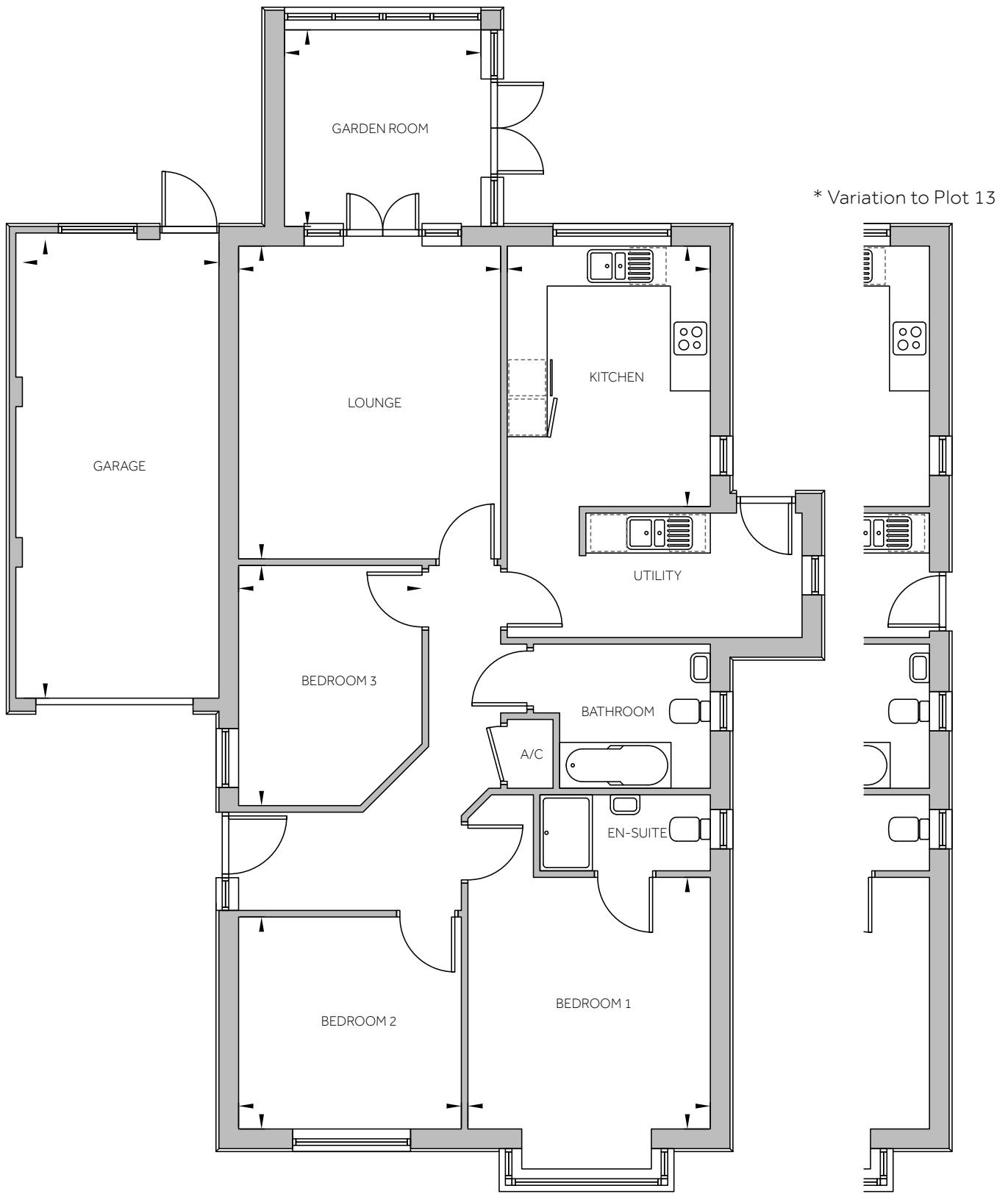

Floor plan indicates Plot 4
 Plot 3 is handed
 * Variation - reduced utility area to Plot 13

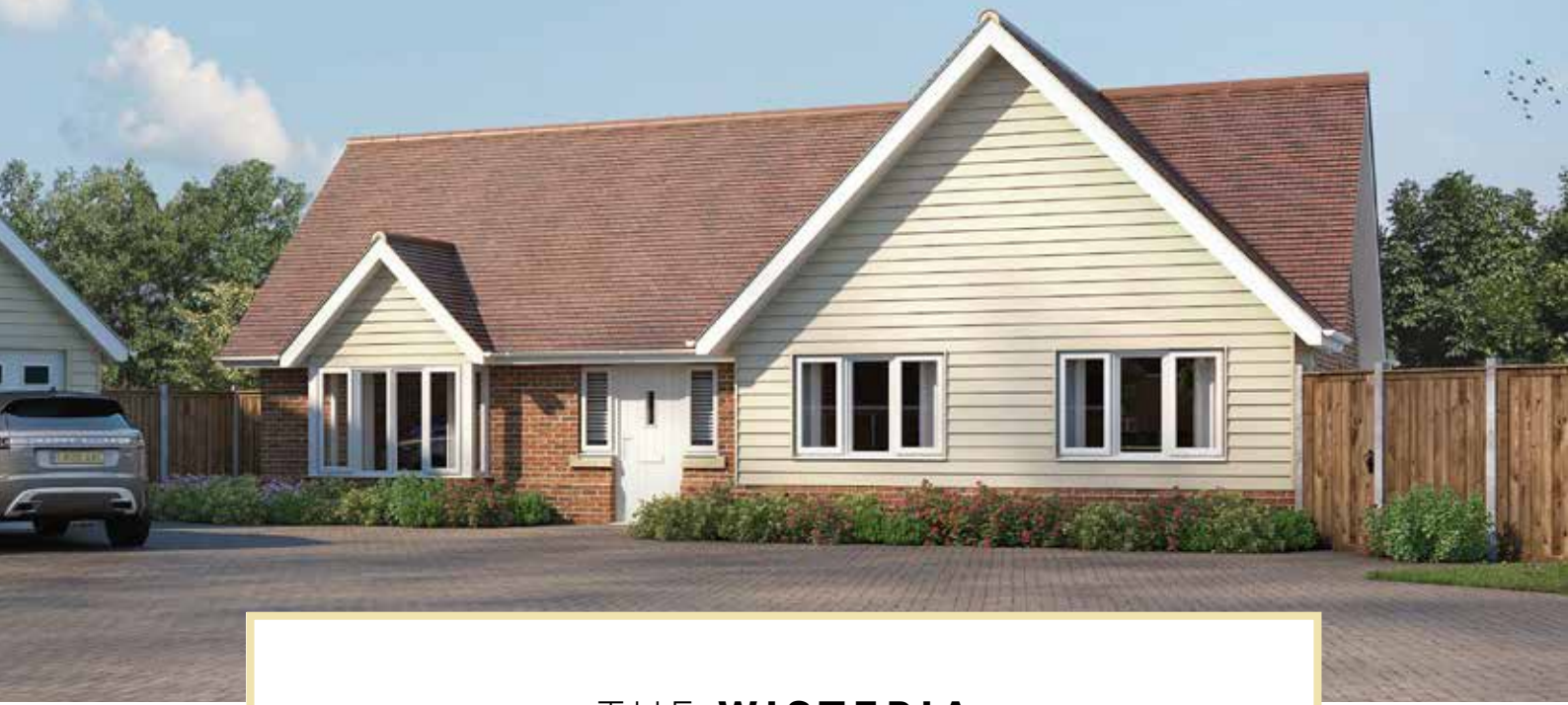





THE WISTERIA

PLOT 8

An elegantly light-filled three-bedroom bungalow with spacious lounge complete with bay window and glazed double doors leading to the garden room. Combined with French doors from the master bedroom to the garden, large corner plot and ample patio area with idyllic river views, the Wisteria offers the perfect relaxation spaces.

CGI indicates
Plot 8

	 	 
Lounge	4.00 x 5.60m	13'1" x 18'4"
Kitchen	3.50 x 3.60m	11'6" x 11'10"
Garden Room	3.00 x 3.00m	9'10" x 9'10"
Bedroom 1	4.00 x 3.60m	13'1" x 11'10"
Bedroom 2	3.00 x 4.10m	9'10" x 13'5"
Bedroom 3	2.50 x 3.00m	8'2" x 9'10"
Garage	7.00 x 3.00m	23'0" x 9'10"



Approximate Gross Internal Area 106.9m² / 1,151ft²

Gross Internal Area includes garden rooms. Illustrations are for marketing purposes only; external finishes and dimensions may vary. Internal room sizes are subject to a 30mm reduction to all walls to allow for internal finishes.

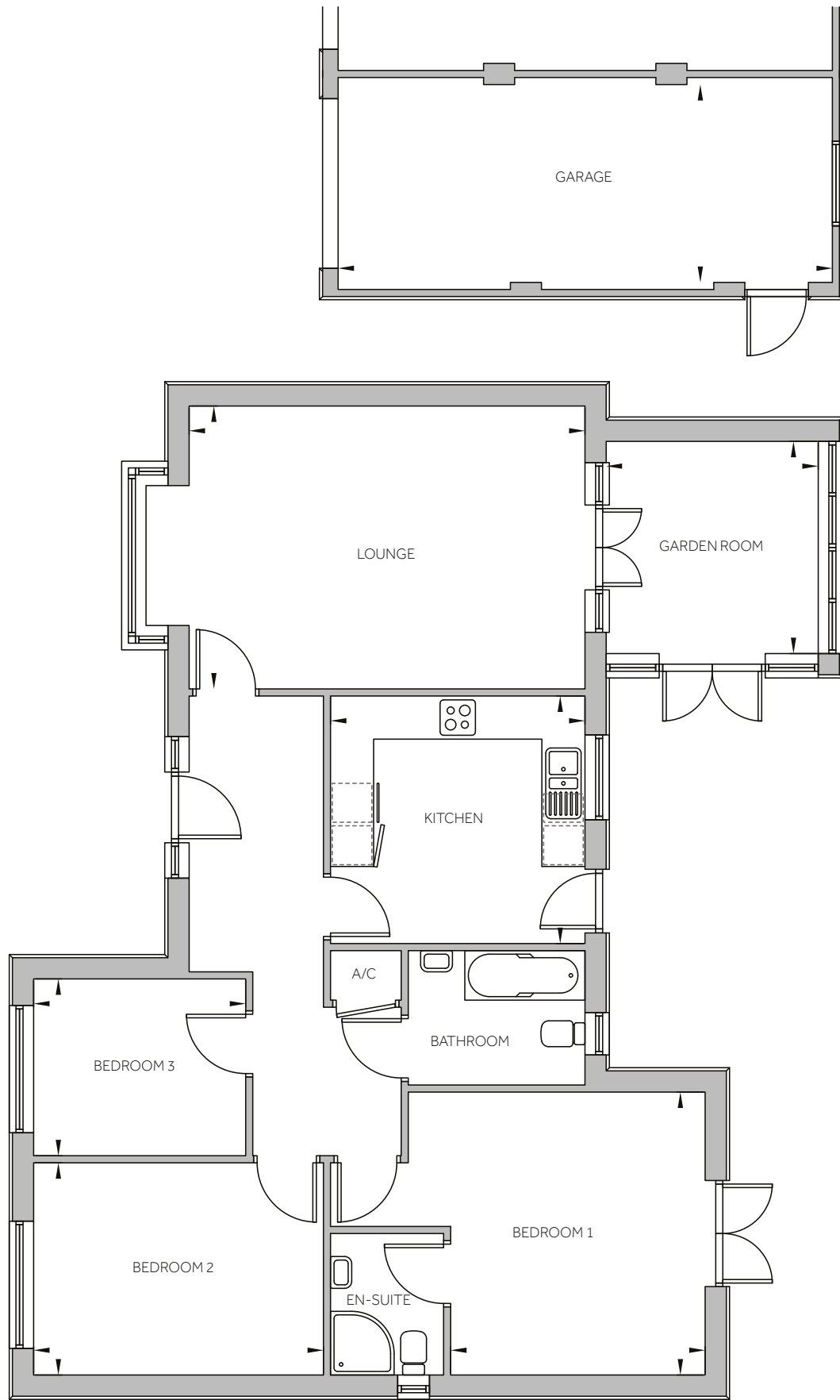

Floor plan indicates Plot 8
Semi detached garage location is indicative only









THE PRIMROSE

PLOTS 17 & 18

Offered as semi-detached, this property provides three good sized bedrooms with en suite shower room to master bedroom, a large kitchen diner and separate lounge. French doors lead from the kitchen diner onto the patio area and into the garden.

CGI indicates
Plot 18

	  	  
Lounge	3.75 x 3.90m	12'4" x 12'10"
Kitchen	3.00 x 7.05m	9'10" x 23'2"
Bedroom 1	2.95 x 3.85m	9'8" x 12'8"
Bedroom 2	3.80 x 2.80m	12'6" x 9'2"
Bedroom 3	2.70 x 2.90m	8'10" x 9'6"
Garage	7.00 x 3.00m	23'0" x 9'10"



Approximate Gross Internal Area 95.4m² / 1,027ft²

Illustrations are for marketing purposes only; external finishes and dimensions may vary.
Internal room sizes are subject to a 30-60mm reduction to all walls to allow for sound proofing & internal finishes.

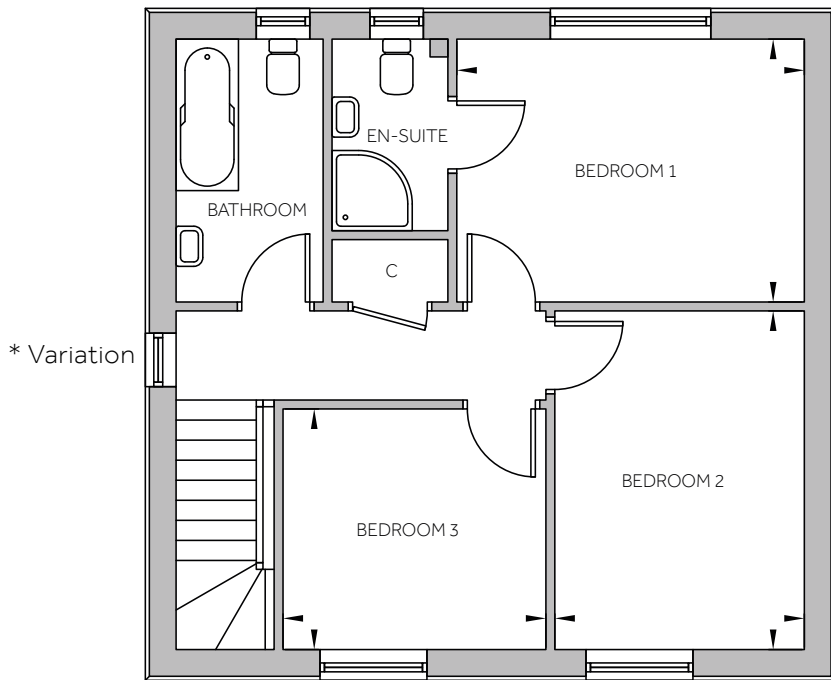

First Floor

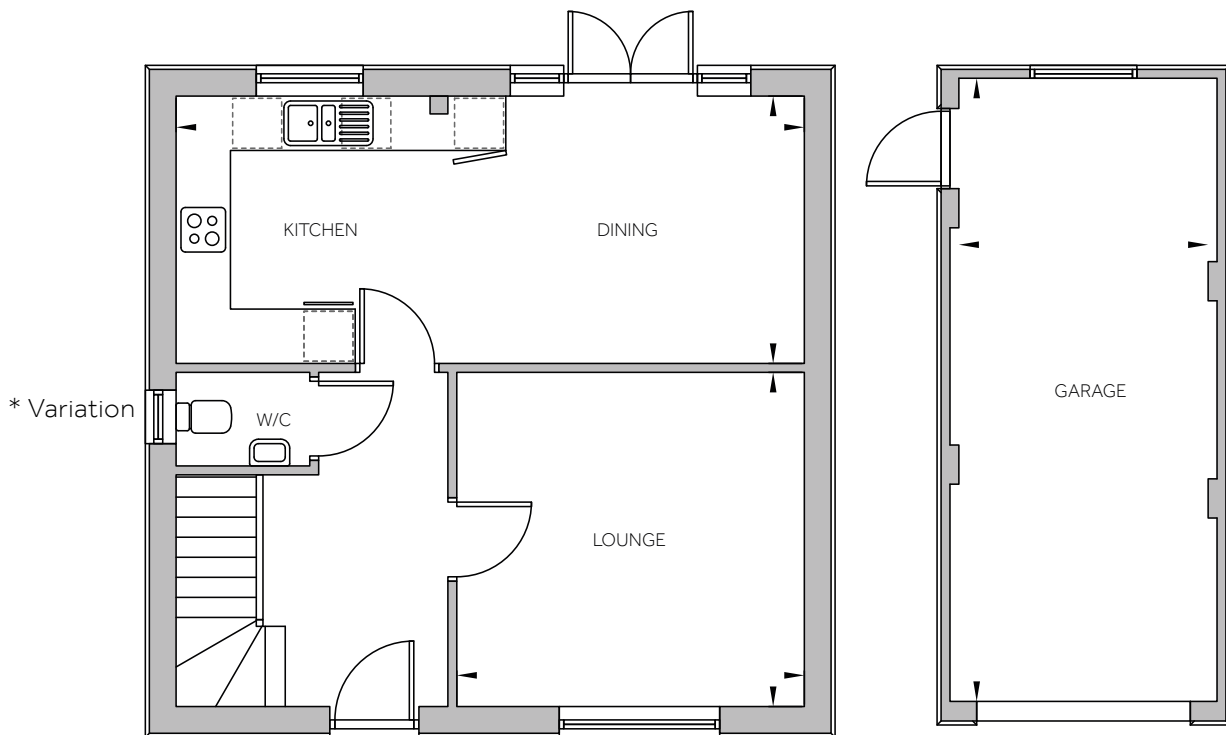

Ground Floor

Floor plan indicates Plots 17 & 18

Garage orientation and layout is indicative only, refer to site plan

* Variation - WC window & landing window to Plot 17 only

Semi detached garage to Plot 17







THE **FUCHSIA**

PLOTS 14 & 16

The Fuchsia is a detached house providing three bedrooms with en suite shower room to master bedroom. A generously sized open plan kitchen diner with breakfast bar creates the perfect socialising and entertaining space with family and friends. French doors from both the lounge and kitchen diner lead directly to the large patio area overlooking the garden.

CGI indicates
Plot 14

	 	 
Lounge	6.00 x 3.20m	19'8" x 10'6"
Kitchen	6.00 x 3.20m	19'8" x 10'6"
Bedroom 1	4.10 x 3.20m	13'5" x 10'6"
Bedroom 2	3.00 x 3.20m	9'10" x 10'6"
Bedroom 3	2.90 x 3.20m	9'6" x 10'6"
Garage	7.00 x 3.00m	23'0" x 9'10"



Approximate Gross Internal Area 104.2m² / 1,122ft²

Illustrations are for marketing purposes only; external finishes and dimensions may vary. Internal room sizes are subject to a 30mm reduction to all walls to allow for internal finishes.

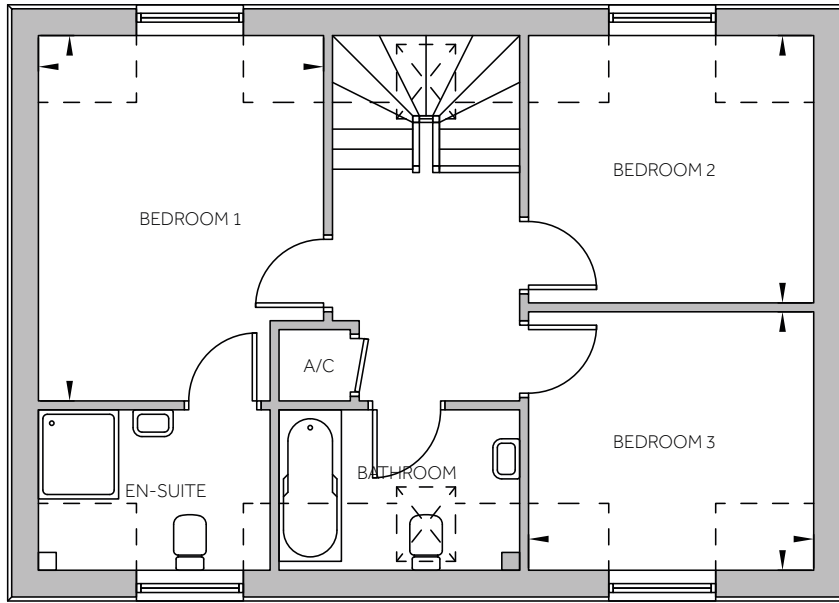

First Floor

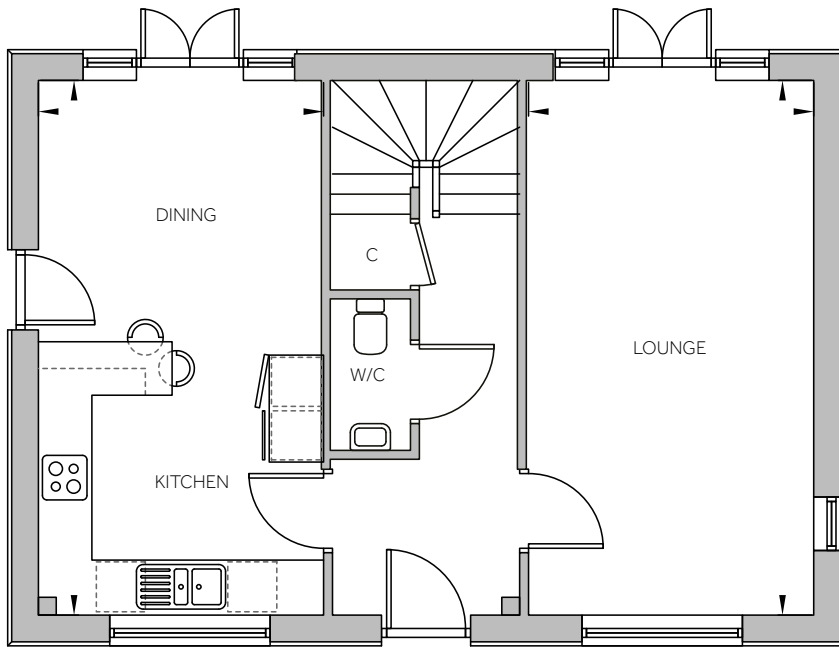

Ground Floor

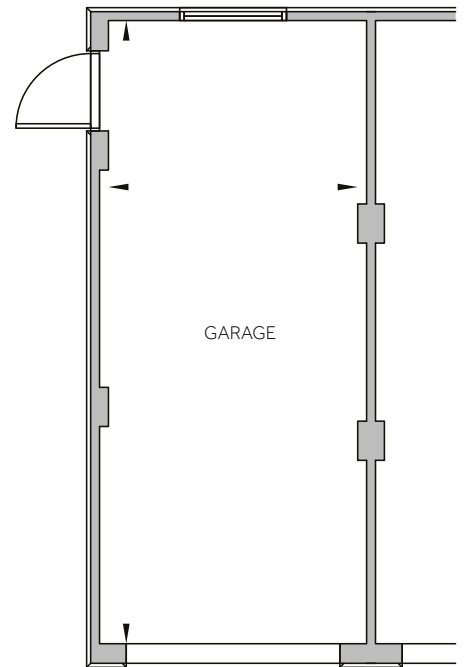

Floor plan indicates Plots 14 & 16
 Semi detached garage location is indicative only
 - - - Reduced ceiling height





CGI indicates
Plot 19

THE VIOLET

PLOT 19

Our premium property, the Violet is a four-bed detached house benefiting from a spacious lounge, kitchen diner with separate utility area and four double bedrooms, with en suite shower room to master. French doors from both the lounge and kitchen diner lead directly to the large patio area overlooking the garden.

		
Lounge	6.00 x 3.60m	19'8" x 11'8"
Kitchen	5.63 x 4.00m	18'5" x 13'1"
Bedroom 1	3.28 x 4.00m	10'9" x 13'1"
Bedroom 2	2.83 x 4.00m	9'5" x 13'1"
Bedroom 3	2.95 x 3.60m	9'8" x 10'10"
Bedroom 4	2.95 x 3.00m	9'8" x 9'10"
Garage	7.00 x 3.80m	23'0" x 12'6"



Approximate Gross Internal Area 135.3m² / 1,456ft²

Illustrations are for marketing purposes only; external finishes and dimensions may vary.
Internal room sizes are subject to a 30mm reduction to all walls to allow for internal finishes.

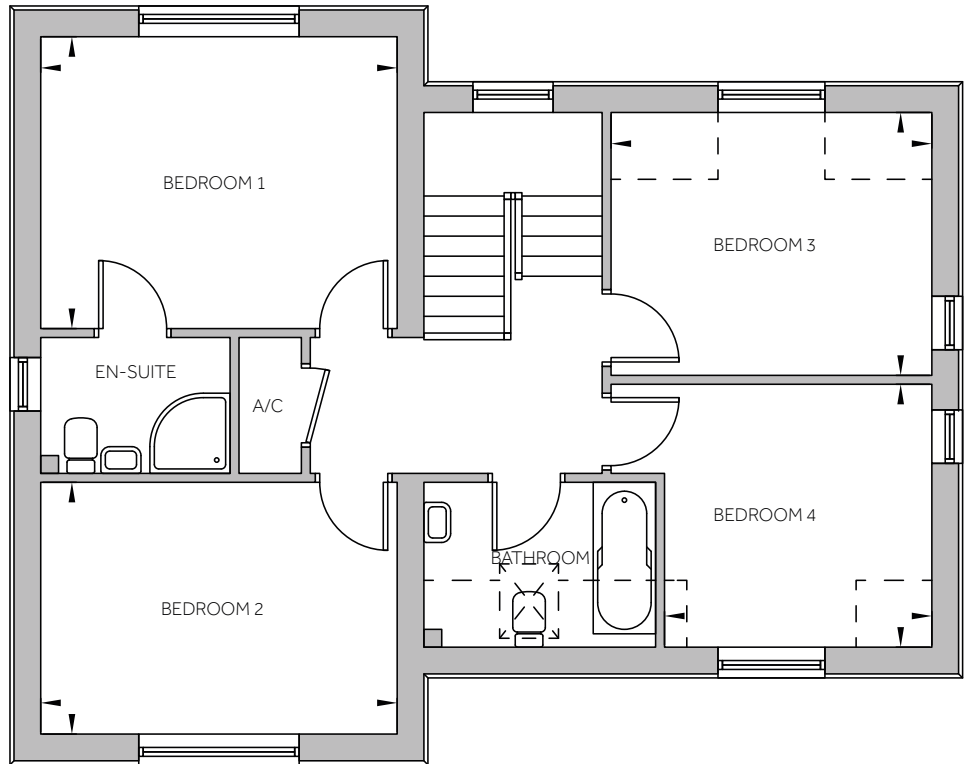

First Floor

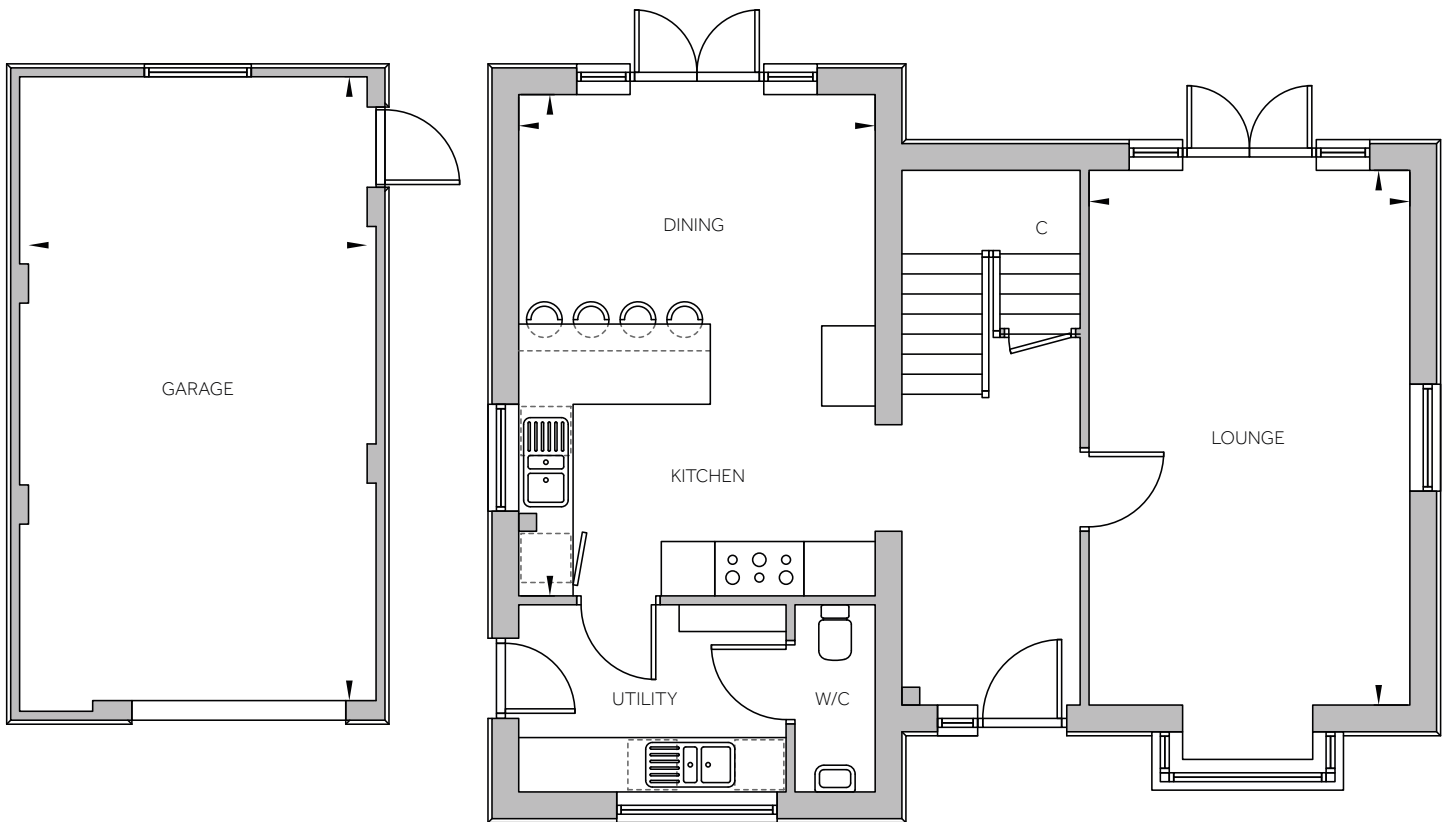

Ground Floor

Floor plan indicates Plot 19
 Garage location is indicative only
 - - - Reduced ceiling height



SPECIFICATION

Coulson Gardens represents a refreshing blend of traditionally built homes with all of the benefits of modern, energy saving materials and appliances. Tailored to you, we provide you with the choice of flooring, tiles, worktops and more, all as standard.

All of our homes are covered by an extensive NHBC Buildmark 10 year warranty.

Scott Residential properties are Secured by Design approved. Secured by Design is a flagship UK police initiative to help 'design out' crime through the use of high-quality innovative products and processes. We have always achieved Gold standard, the highest level of accreditation, and would expect Coulson Gardens to follow suit.





INTERNAL FINISHES

Walls finished with Super Matt emulsion and Diamond Matt emulsion to bathrooms, kitchen and utility

Four panel oak interior doors with polished chrome ironmongery

Chamfered and grooved skirting and architrave finished with white Satinwood paint

Choice of carpets to lounge, bedrooms, hallway and garden room where applicable

Choice of Inspiration Luxury Design vinyl floor tiles to kitchen, utility, bathroom, en suite and cloakrooms where applicable



BATHROOM & EN SUITES

Bathroom suite including shower head over bath, and shower enclosure to en suite

LED mirror with demisting pad and integrated shaver point

Ceiling mounted extractor fan

Wash hand basin vanity unit with mixer tap

Large low profile shower tray to en suite

Choice of Inspiration Luxury Design vinyl floor tiles and glazed wall tiles to wet areas



KITCHEN & UTILITY

Large choice of laminate 40mm worktops, glazed wall tiles and Inspiration Luxury Design vinyl floor tiles

Eye-level built-in double fan oven and grill, electric hob with stainless steel curved glass extractor with hood light

Luxurious shaker style units and matching eye-level cabinets with under cabinet lighting

Stainless steel one and a half bowl sink unit with Monobloc sink mixertap

Energy efficient integrated appliances; washing machine, dishwasher and fridge freezer, with tumbler dryer where applicable





ELECTRICAL & CONNECTIVITY

Wired intruder alarm system and wired 'Ring' video doorbell to front door

Wired smoke alarm and linked heat sensor

TV, Sky and BT points to lounge, kitchen and bedrooms

Double sockets throughout with USB connections in lounge, kitchen and bedrooms

Downlights to kitchen and bathroom areas, with pendant lighting to all other rooms and wall light fittings to lounge

Lighting at exterior door locations

External 240v socket to rear of property



CENTRAL HEATING

Air source heat pump system

Radiators throughout with thermostatic valves, with towel radiator to bathrooms

Hot water cylinder with immersion heater





EXTERNALLY

Level access to front of property

Double glazed UPVC windows & doors

Porcelain paved patio area

Outside tap to rear of property

Cultivated turf to front and rear gardens

Landscaped planting to front garden

Timber fence panels with trellis, concrete posts and gravel boards



GARAGE

Electric sectional door with remote control

Side or rear entry personnel door and window where applicable

Fluorescent lighting and 240v double sockets

Designated wiring installed for electric car charging port









BRAINTREE VILLAGE,
BRAINTREE



CLACTON BEACH,
CLACTON-ON-SEA

THE LOCATION

Coulson Gardens is perfectly positioned, whether commuting, travelling for leisure or exploring the countryside.

Coulson Gardens,
Church Lane, Bocking,
Braintree, Essex,
CM7 5SE



VILLAGE CLUB & RESTAURANT,
BOCKING



BOWLING CLUB,
BRAINTREE



TENNIS COURTS,
BRAINTREE & BOCKING PUBLIC GARDENS

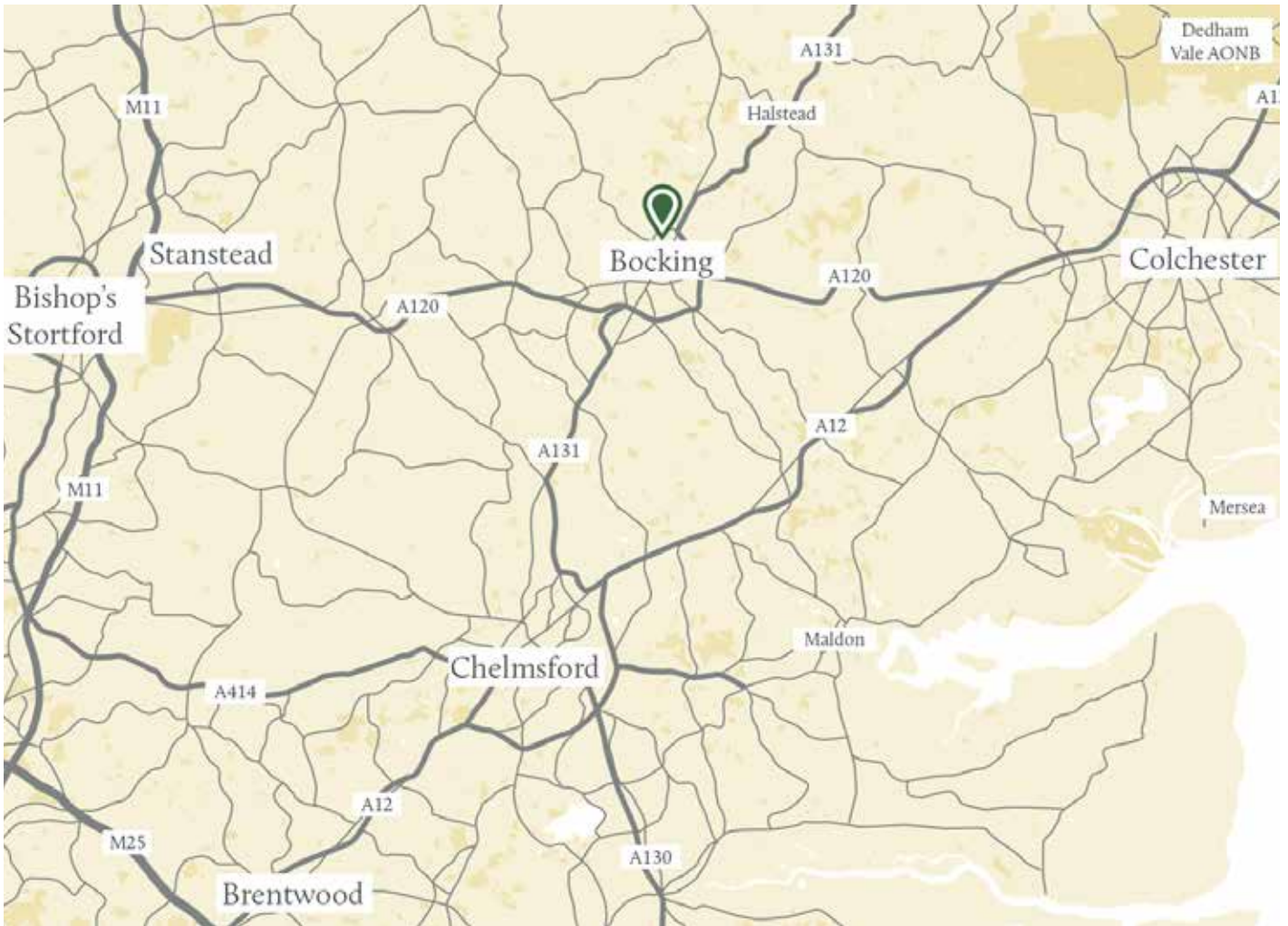

CLOSE BY

- Bus Stop – 60 metres
- Braintree & Bocking Public Gardens – 0.5 miles
- Braintree Train Station – 1.2 miles
- Braintree High Street Shops – 1.2 miles
- Braintree Designer Village – 1.8 miles
- Braintree Golf Club – 3.2 miles



RAIL LINKS FROM BRAINTREE

- Braintree Designer Village – 2 minutes
- Witham – 16 minutes
- Colchester – 33 minutes
- Chelmsford – 35 minutes
- Manningtree – 1 hour 7 minutes
- London Liverpool Street – 1 hour 10 minutes



ROAD CONNECTIONS

- A120 Great Notley junction – 2.2 miles
- A12 Rivenhall junction – 9.5 miles
- Chelmsford – 13 miles
- Stanstead Airport – 16 miles
- Colchester – 17 miles
- M25 Jct 28 – 30 miles



PLACES OF INTEREST

- Great Notley Country Park – 4 miles
- Colne Valley Railway – 8.2 miles
- Marks Hall Estate – 9.2 miles
- Perrywood Garden Centre – 11.4 miles
- Colchester Zoo – 15.6 miles
- Dedham Vale AONB – 24 miles

All travel times and distances are approximate only. Train times listed are from Braintree Station based on current approximate off-peak National Rail timings. Rail journeys may be longer during peak times.



FOR FURTHER INFORMATION PLEASE CALL
NICHOLAS PERCIVAL ON **01206 563222**



All photographs, plans and computer generated images within this brochure are indicative and for illustration purposes only. The dimensions given on plans are subject to minor variations and are not intended to be used for carpet sizes, furniture sizes or for any other use. This brochure and the information within does not constitute or form part of any contract. Any buyer must satisfy him/herself by inspection or otherwise as to the correctness of any information.